

»multifix« series

Rotary switch can be turned 90°, lockable, with relief port.

Max. input pressure: 16 bar
 Max. medium temperature: 60 °C
 Max. ambient temperature: 60 °C
 Operation: Twist knob, rotatable 90°
 Sealant: NBR
 Flow rate measurement: At $P_1 = 6$ bar and pressure drop $\Delta p = 1$ bar

Ball valve, 3/2-way

Art. No.	Type No.	Thread	Vent port	Housing	Flow rate l/min	Size
133133	K 44	G 3/4	Silencer G 1/2	Die-cast aluminium	30000	4

Accessories / spare parts

Art. No.	Type No.	Description
135858	ZW 45	Mounting bracket with 2 screws
135857	KP 45	Coupler pack for modular assembly of several devices

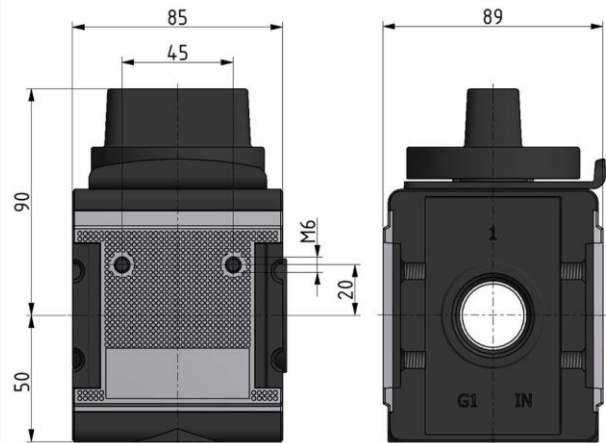

flow characteristic

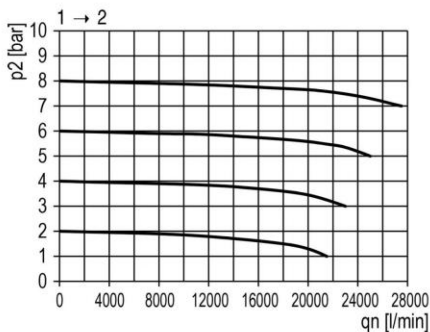

rear exhaust

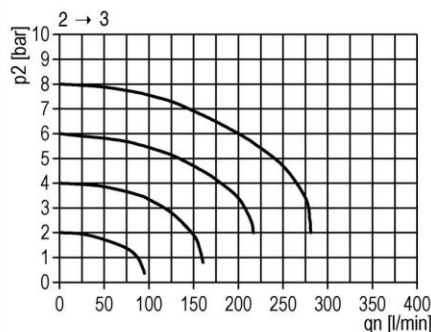

symbol

